

SR-LD 200



Detector



Fig. 1: Detector **SR-LD 200**

Display

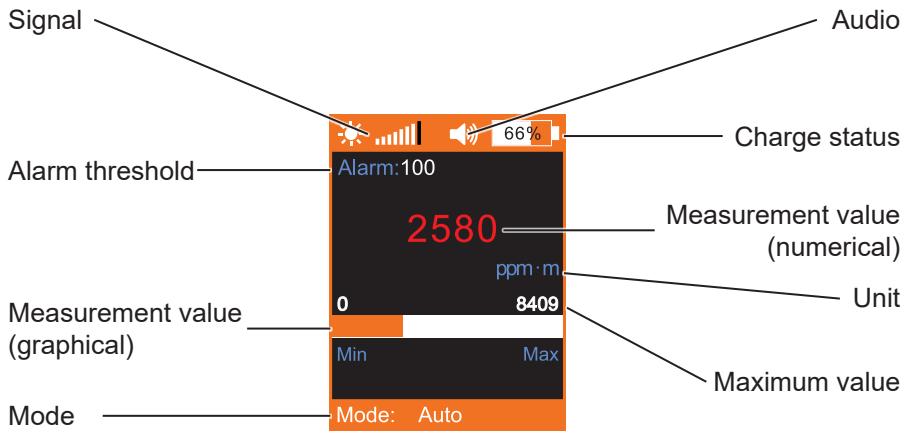

Fig. 2: Display of the **SR-LD 200** – Measuring mode
(*here*: Laser activated, alarm threshold exceeded)

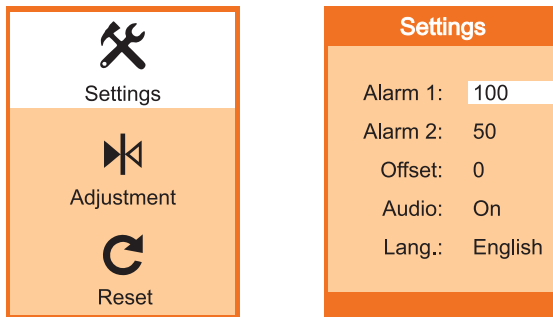

Fig. 3: Display of the **SR-LD 200** – Menu
Left image: Main menu
Right image: **Settings** menu

Illustration of warnings in this document



DANGER!

Risk of personal injury. Will result in serious injury or death.



WARNING!

Risk of personal injury. Could result in serious injury or death.



CAUTION!

Risk of personal injury. Could result in injury or pose a risk to health.

NOTICE!

Risk of damage to property.

1	Introduction	1
1.1	Information about this document.....	1
1.2	Purpose	1
1.3	Intended use	2
1.4	Safety information	2
2	Product description	4
2.1	General information.....	4
2.2	Features	4
2.2.1	Lasers	4
2.2.2	Sight	5
2.2.3	Power supply.....	6
2.2.4	Adjustment unit	6
2.3	Measuring mode and menu	7
2.3.1	Measuring mode	7
2.3.2	Menu	8
2.4	Modes	9
2.5	Audible signal.....	9
2.6	Measured variable and unit.....	10
3	Operation	12
3.1	Key functions.....	12
3.2	Switching the detector on/off	13
3.3	Switching the lasers on/off	13
3.4	Switching mode	14
3.5	Switching between measuring mode and menu	15
3.6	Adjusting settings	15
3.6.1	Changing settings	15
3.6.2	Deactivating/activating the audible signal for exceeding the alarm threshold	15
3.6.3	Resetting to factory settings.....	16
3.7	Aiming at the target	17
3.7.1	Aiming using the target laser.....	17
3.7.2	Aiming using the sight.....	17
4	Detection of methane.....	19
4.1	Requirements.....	19
4.2	Influences on the measurement result	19
4.3	Measuring the gas concentration	20
4.4	Common errors	20

5	Settings	22
5.1	Alarm 1 and Alarm 2.....	22
5.2	Offset.....	23
5.3	Audio	23
5.4	Language	23
6	Maintenance	24
6.1	Detector.....	24
6.1.1	Adjusting the detector	24
6.1.2	Configuring the sight	25
6.1.3	Caring for, storing and transporting the detector.....	27
6.1.4	Servicing	28
6.2	Rechargeable battery	28
6.2.1	Charging the battery.....	28
6.2.2	Replacing the rechargeable battery	29
6.2.3	Maintaining and storing the rechargeable battery	29
6.2.4	Handling faulty lithium-ion rechargeable batteries	30
7	Faults and problems	31
7.1	Error messages.....	31
7.2	Fixing problems yourself	31
8	Appendix.....	33
8.1	Technical data	33
8.2	Delivery contents.....	35
8.3	Factory settings.....	35
8.4	Sticker on the detector and rechargeable battery	36
8.5	Symbols on the display	37
8.6	Conversion of concentration data	37
8.7	Terminology and abbreviations	37
8.8	Declaration of Conformity.....	38
8.9	Advice on disposal	38
9	Index.....	39

1 Introduction

1.1 Information about this document

This document is a part of the product.

- Read the document before commissioning the product.
- Ensure easy access to the document.
- Pass this document on to any subsequent owners.
- Unless otherwise specified, the information in this document refers to the product as delivered (factory settings).
- Differing national legal regulations take precedence over the information in this document.

Translations

Translations are produced to the best of our knowledge. The original German version is authoritative.

Right of reproduction

No part of this document may be edited, duplicated or circulated in any form without the express consent of Hermann Sewerin GmbH.

Registered trademarks

Registered trademarks are generally not indicated in this document.

1.2 Purpose

SD-LR 200 is a portable detector for measuring methane concentrations, in particular at a long distance and in areas which are hard to access.

This product can be used for detecting gas from exposed gas pipelines and installations such as:

- bridge gas pipelines
- compressor systems
- biogas systems

1.3 Intended use

The product is suitable for the following uses:

- professional
- industrial

The product may be used only for the applications specified in section 1.2.

1.4 Safety information

This product was manufactured in accordance with all binding legal and safety regulations.

The product is safe to operate when used in accordance with the instructions provided. However, when handling the product, there may still be risks to persons and property. For this reason, observe the following safety information without fail.

- Observe all the applicable safety standards and accident prevention regulations.
- Use the product only as intended.
- Handle the product carefully and safely, both during transport and operation.
- Do not make any changes or modifications to the product unless these have been expressly approved by Hermann Sewerin GmbH.
- Do not use the product if it is damaged or faulty. Never use damaged or defective accessories.
- Only ever use accessories approved by Hermann Sewerin GmbH.
- Always observe the permitted operating and storage temperatures.
- Never operate the product in the vicinity of explosive environments.
- Protect connections against dirt, and electrical connections, in particular, against moisture.
- Do not submerge the product in liquids.

Laser

The measurement laser is an invisible Laser Class 1 infrared laser. Lasers in this category are harmless when the product is used as intended.

- However, do not look into the laser beam because blinding, impairment of colour vision or irritation cannot be excluded.

The target laser is part of Laser Class 2. It is visible as a green beam. Lasers in this category are harmless to the eye with very short exposure (< 0.25 s). Longer exposure can cause health damage.

- Do not deliberately look into the laser beam or its reflection.
- Immediately close your eyes and turn away if a Class 2 laser beam accidentally hits your eye.
- Never aim the laser beam at people.

Lithium-ion rechargeable battery

- Risk of short circuit! Do not touch the power connector poles with metal.
- Never try to open the rechargeable battery.
- Do not use the rechargeable battery if it is damaged.
- Prevent the ingress of moisture into the rechargeable battery.
- Protect the rechargeable battery from mechanical loads (impact, vibration). Never drop the rechargeable battery.
- Observe the permissible conditions during charging, storage and operation. Protect the rechargeable battery against very low and high temperatures even when these are in the permissible range.
- Only ever charge the rechargeable battery using the charger supplied.
- Never throw the rechargeable battery into an open fire.
- Dispose of the rechargeable battery in accordance with applicable guidelines.

2 Product description

2.1 General information

The **SR-LD 200** Detector works according to the TDLAS method and has been designed for the remote detection of methane.

A laser beam emitted by the detector is reflected by a surface (e.g. wall, ground, pipeline). If there is methane along the measuring section, the methane will absorb the laser beam signal. The methane concentration can be calculated from the extent of the signal absorption.

The advantage of this method is that the measurement result is not influenced by interference from other hydrocarbons.

2.2 Features

You can find an overview with the names of the detector parts inside the front cover (fig. 1).

The detector is equipped with Bluetooth, meaning the measurement values can be recorded using an app.

2.2.1 Lasers

The detector features several lasers.

- **Measurement laser**

The measurement laser is an invisible infrared laser. The measurement laser is used to measure gas concentration.

- **Target laser**

The target laser is a visible laser. Use its green laser beam to aim at the target.

The exit openings of both lasers are located above the lens (fig. 1).

The measurement laser will increase in width the further it is from the reflective surface (fig. 5). This increases the area of the reflection point and the intensity of the reflected beam becomes weaker. The measurement laser's reflection will be diffuse, i.e. the light is scattered.

Please see section 4.2 for information about the effect of the reflective surface on the laser beam's reflection capacity.

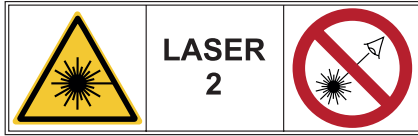

Fig. 4: Warning on the detector
 Meaning: laser radiation. Class 2 laser. Do not look into the laser beam!
 Note: The warning does not show all laser classes but just the highest.

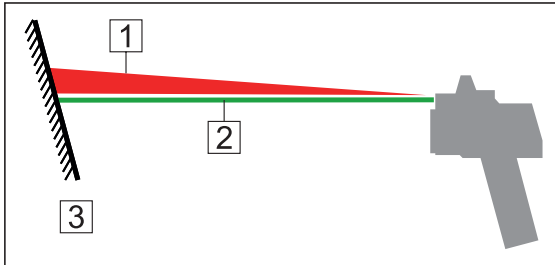

Fig. 5: Lasers
 [1] Measurement laser, [2] Target laser, [3] Reflective surface

2.2.2 Sight

The detector features a red dot sight. A red dot sight is optical sight equipment where a target can be aimed at with both eyes open.

In a red dot sight, a colourful red dot is generated on a projection screen in the lens. The dot does not illuminate the target but is only visible when the user looks through the sight equipment. The user can see both the red dot and the target laser when looking through the sight.

The sight has been designed for long distances and is always set for a specific distance.

As soon as the detector has been switched on, the sight can be used.

Information about aiming using the sight can be found in section 3.7.2. For configuring the sight, see section 6.1.2.

2.2.3 Power supply

The detector is powered by a lithium-ion rechargeable battery. The rechargeable battery is integrated in the handle.

Information about charging the rechargeable battery can be found in section 6.2.1.

2.2.4 Adjustment unit

The adjustment unit consists of a gas tank fixed in a plastic block. The gas tank contains adjustment gas.

The adjustment unit is integrated in the case (fig. 6, right image). After the adjustment process is started, the detector is placed in the case. This aims the measurement laser at the adjustment unit and automatically adjusts it.

NOTICE!

Risk of destruction in the event of external impact

The gas tank is fragile because it is made of glass.

- Never place tools, small parts or similar in the recess in the case which is designated for the detector.
-

Information about performing an adjustment can be found in section 6.1.1.



Fig. 6: Adjustment unit
Left image: Adjustment unit outside the case
Right image: Adjustment unit inside the case

2.3 Measuring mode and menu

2.3.1 Measuring mode

When switched on, the detector is automatically in measuring mode. To perform a measurement, the lasers must be switched on manually.

As soon as the lasers are switched on and the measurement laser meets a reflective surface, the following measurement values can be seen on the display:

- current measurement value (numerical and graphical)
- maximum value (numerical)

This means that the detector constantly measures the methane concentration in the area even if the laser coincidentally meets a reflective surface.

Inside the front cover, there is an overview of the symbols, values and other information shown on the display during the measuring mode (fig. 2, top image).

Information about targeted detecting can be found in section 4.

Alert when the alarm threshold is exceeded

If a measurement value exceeds the alarm threshold, the detector will trigger an alarm.

- The current measurement value is in red (fig. 7, right image).
- An audible signal can be heard when the audible signal is activated (section 3.6.2).

The alert stops as soon as the measurement value falls below the alarm threshold.

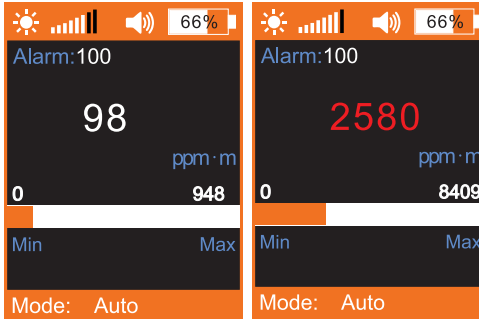

Fig. 7: Measuring mode
(here: Laser activated, alarm threshold 100 ppm·m)
 Left image: Measurement value below the alarm threshold
 Right image: Measurement value exceeds the alarm threshold

2.3.2 Menu

If you want to open the menu, the detector must be in measuring mode.

In the menu, the user can adjust settings and perform actions.

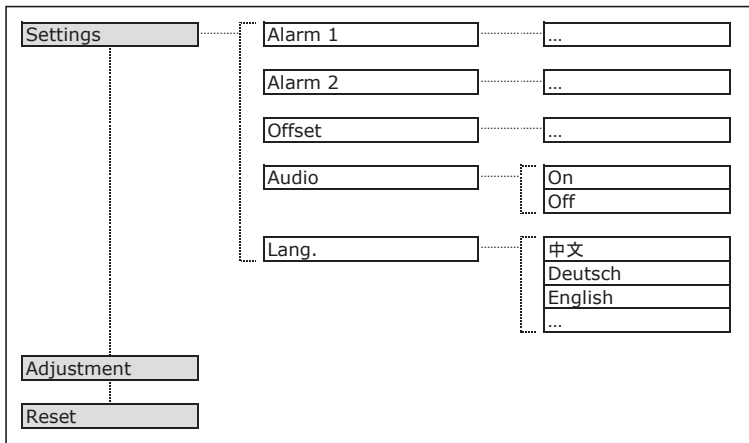

Fig. 8: Menu (menu structure)

The top level of the menu is the main menu. The main menu comprises the following menu items:

- **Settings** (section 5)
- **Adjustment** (section 6.1.1)
- **Reset** (section 3.6.3)

2.4 Modes

The detector can be operated in various modes. The various modes are suitable for use based on different distances.

- **Sensitivity**

Mode particularly suitable for distances up to 30 m. The detector is very sensitive.

- **Distance**

Mode very suitable for long distances. The detector is less sensitive than in **Sensitivity** mode.

- **Auto**

Mode equally suitable for short and long distances. The detector will automatically adjust the zero point of the measurement laser until the distance changes.

2.5 Audible signal

The detector will sound an audible signal in the following situations:

- detector ready after being switched on
- measurement value exceeds the alarm threshold
- adjustment completed

Note:

The audible signal for exceeding the alarm threshold can be deactivated (section 3.6.2).

2.6 Measured variable and unit

The detector measures the gas concentration along the measuring section. The gas concentration is specified in ppm, the size (length) of the gas cloud in metres. The unit of the measured variable is therefore:

ppm•m (concentration multiplied by length)

Integral gas concentration

The measured variable is described as integral gas concentration.¹ The integral gas concentration depends on the following:

- Concentration of the gas in the gas cloud
- Size (length) of the gas cloud along the measuring section

The measurement result can be the same with a small, highly concentrated gas cloud as a larger gas cloud with a lower concentration (fig. 9).

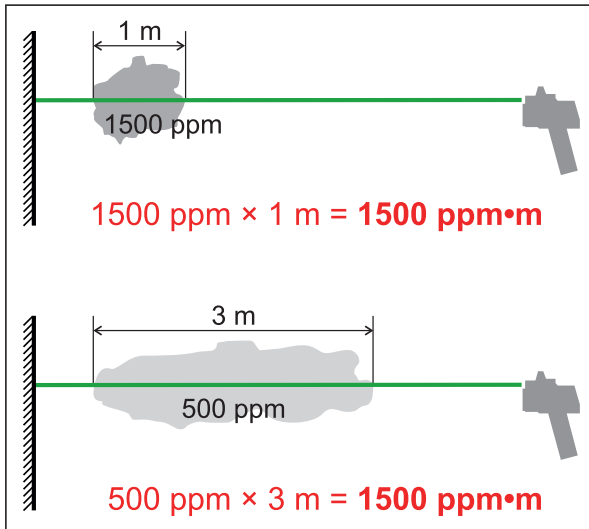

Fig. 9: Integral gas concentration – identical measurement value despite different gas concentration and size of the gas cloud

¹ Other usual descriptions are, for example, path-integrated concentration, relative gas concentration

In addition, the naturally occurring methane (~1 ppm) in the ambient air affects the measurement value. The impact of the natural methane increases the further the distance between the laser and the reflective surface. The natural methane content along the measuring section must be deducted from the measurement value.

	Example 1	Example 2
Measurement value	1500 ppm•m	1500 ppm•m
Methane content in the environment	1 ppm	1 ppm
Distance between detector and reflective surface	20 m	80 m
Integral gas concentration in the gas cloud: measurement value - (methane content × distance)	1480 ppm•m	1420 ppm•m

3 Operation



3.1 Key functions

Depending on the situation, the keys have different functions.



When switched off

Key	Actions
 On/Off key	– Switch the detector on (long press)

In measuring mode

Key	Actions
 On/Off key	– Switch the laser on and off (short press) – Switch the detector off (long press)
 Menu key	– Open the main menu (short press) – Switch the mode (long press)

In the menu (main menu and settings menu)

Key	Actions
 On/Off key	– Open the selected menu item – Apply the setting – Switch the detector off (long press)
 Menu key	– Move from the bottom to the top – When the first menu item is selected: skip to the last menu item
 Selection key	– Move from the top to the bottom – In the main menu, when the last menu item is selected: return to measuring mode – In the Settings menu, when the last menu item is selected: return to the main menu

3.2 Switching the detector on/off

Switching on

The detector is switched off.

1. Press the On/Off key until the start image (fig. 10) appears.
2. Wait until you can hear an audible signal.

The detector is in measuring mode (fig. 2, top picture). The lasers are switched off.

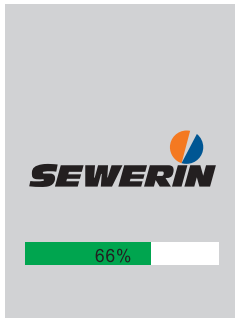

Fig. 10: Start image

Switching off

When the detector is switched off, the current mode and the current settings are saved.

The detector is switched on.

- Press the On/Off key until the detector is switched off.

3.3 Switching the lasers on/off

For detection, the lasers must be switched on manually. When switching off the detector, any lasers that are switched on are automatically switched off.

Note:

The measurement laser and the target laser are always switched on or off together.

For safety reasons, SEWERIN recommends the following: switch off the lasers temporarily when the detector is switched on but you are not in the process of detecting.



CAUTION! Risk of injury from laser radiation

Class 2 lasers can cause eye damage.

- Observe the safety instructions when working with laser radiation (section 1.4).
-

Switching on

The detector is in measuring mode. On the display, you can see **Laser off**.

- Briefly press the On/Off key.

The display shows the current measurement value. The lasers are switched on.

Switching off

The lasers are switched on.

- Briefly press the On/Off key.

On the display, you can see **Laser off**. The lasers are switched off.

3.4 Switching mode

When switching mode, the options are displayed in a loop.

The detector is in measuring mode.

1. Press and hold the menu key until the mode changes.
2. If required:
 - repeat the process until you have selected the required mode.

Information about the modes can be found in section 2.4.

3.5 Switching between measuring mode and menu

Opening the main menu

The detector is in measuring mode.

- Briefly press the menu key. The main menu appears. The selected menu item is highlighted in white.

Switching back to measuring mode

The main menu is open.

- Keep pressing the selection key until the detector switches to measuring mode.

3.6 Adjusting settings

3.6.1 Changing settings

The detector is in measuring mode.

1. Open the main menu.
2. Select **Settings**. The **Settings** menu will appear.
3. Select the menu item for which you would like to change the setting.

The selected menu item is highlighted in white.

4. Change the setting as required.
5. Press the On/Off key to apply the setting.

3.6.2 Deactivating/activating the audible signal for exceeding the alarm threshold

If a measurement value exceeds the alarm threshold, an audible signal will sound (factory setting). This audible signal can be deactivated.

The detector is in measuring mode.

1. Open the main menu.
2. Select **Settings**. The **Settings** menu will appear.

3. Select **Audio**.
4. Change the setting as required.
5. Press the On/Off key to apply the setting.

3.6.3 Resetting to factory settings

The current settings can be reset to factory settings at any time. Information about the factory settings can be found in section 8.3.

Note:

The settings will be reset without prompting you for confirmation. As long as **OK** is not pressed, the reset process can be cancelled using **ESC**.

The detector is in measuring mode.

1. Open the main menu.
2. Select **Reset**. The start view of the **Reset** process will appear (fig. 11).
3. Select **OK** to reset the settings.

The settings will be reset. The main menu appears.



Fig. 11: **Reset** – start view

3.7 Aiming at the target

When detecting methane, the target to be aimed at is usually a suitable reflective surface. The leak is assumed to be in front of the reflective surface (fig. 9).

There are two ways of aiming at the target:

- target laser
- sight

You can switch between both options.

Note:

The lasers must be switched on for aiming at the target.

3.7.1 Aiming using the target laser

Aiming using the target laser is particularly suitable for:

- short distances
- weak sunlight

When aiming, direct the green dot of the target laser precisely at the reflective surface.

3.7.2 Aiming using the sight

The sight makes detection easier if the target laser's reflection point is difficult to see or cannot be seen at all. Aiming using the sight is particularly suitable for:

- long distances (from about 30 metres)
- strong sunlight or unfavourable lighting conditions

Note:

The sight is set for a specific distance to the reflective surface.

- Reset the sight before detecting if you want to measure at a different distance from the one that is set.
-

After switching on the lasers, you will see a red dot and the green target laser through the sight (fig. 12, left image). When

the red dot and the target laser overlap during the aiming process (fig. 12, right image), the laser will meet a reflective surface at the set distance.

If the red dot cannot be seen:

- change the angle at which you are looking through the sight.
- pan the detector a little.

If the red dot and the target laser cannot be made to overlap, the distance between the detector and the reflective surface does not match what you have set.

- Adjust the distance between the detector and reflective surface by taking the detector closer to the reflective surface or by moving away from the reflective surface to match the set distance.

OR

- Reset the distance.

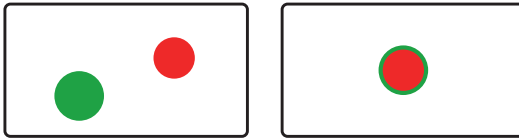

Fig. 12: Aiming using the sight (red: red dot, green: target laser)
Left image: Target laser and red dot detectable in sight
Right image: Target laser and red dot overlapping

General information about the sight can be found in section 2.2.2.
For configuring the sight, see section 6.1.2.

4 Detection of methane

4.1 Requirements

In order to successfully detect methane using the detector, the following requirements have to be met:

- there is methane along the measuring section (detection report)
- the laser must aim through the methane cloud
- there is a reflective surface

4.2 Influences on the measurement result

The following factors influence the measurement result:

- **Detector handling during the measurement process**

The detector must be moved by the user at a slow, smooth speed. If movements are abrupt or too fast, the detector may not measure correctly.

- **Reflective surface**

The material and surface property of the reflective surface have a direct impact on the reflection capability of the laser beam and therefore on the measurement result.

- Ideally suitable surfaces: cement, plaster
- Unsuitable surfaces: less or non-reflective (black wall), highly reflective (mirror, polished stainless steel), porous

Cracks or openings in the reflective surface may result in an increased methane concentration being measured in areas that are quite far from the actual leak.

Usable measurement results can generally also be achieved with less suitable reflective surfaces if the laser beam meets the surface at an appropriate angle.

- **Signal quality**

The signal corresponds to the intensity with which the reflected beam meets the lens. If the signal is too weak or too strong, error messages will be triggered.

- **Ambient conditions**

Wind as well as high ambient temperatures can result in the gas evaporating. Consequently, a methane concentration that is too low will be measured or none at all.

4.3 **Measuring the gas concentration**

To measure the gas concentration, the requirements (section 4.1) must be met.

1. Remove the protective caps from the lens and the sight.
 2. Switch on the detector.
 3. Switch on the laser.
 4. Begin measuring.
 - Aim at a suitable reflective surface.
Depending on the distance, use the target laser or the sight.
 - Scan the environment. Move the detector slowly and smoothly.
- If required:
- change the laser's angle of incidence.
 - adjust the mode and alarm threshold.

If gas concentrations above the alarm threshold are measured, the detector will trigger an alarm.

4.4 **Common errors**

The following errors can affect the measurement:

- the laser does not meet a reflective surface but is aimed at the sky, for example. if the distance is exceeded, the message **Light weak** will appear on the display.
- the measuring section is shorter than 0.50 m.
- the measuring section is longer than the maximum range. if the distance is exceeded, the message **Light weak** will appear on the display.
- Detection through glass: the laser meets the glass at a right angle rather than at an angle unequal to 90°.

- Detection in the case of polyethylene pipelines with a diameter less than 20 millimetres and a very low wall thickness: the detector may measure the gas concentration inside the pipeline.
- there are obstructions along the measuring section (fig. 13 and 14).
- the laser beam generates several reflection points on the reflective surface e.g. surfaces curved inwards or corners (fig. 15).

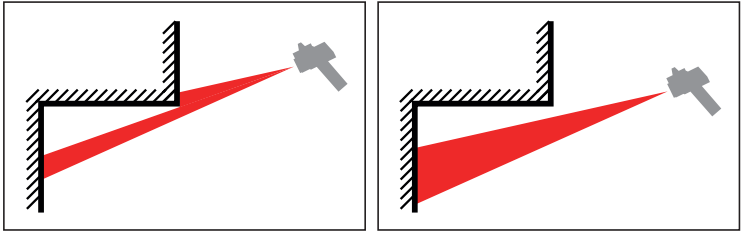

Fig. 13: Error source during measuring (1)
 Left image: Obstruction along the measuring section
 Right image: Measuring without obstruction after change of position

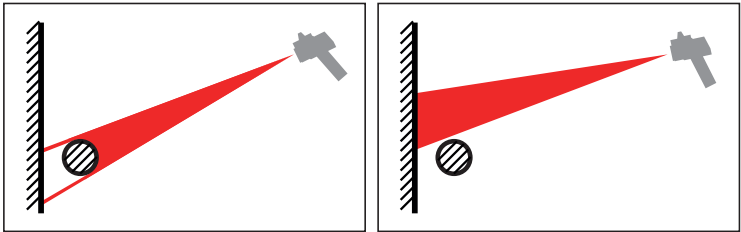

Fig. 14: Error source during measuring (2)
 Left image: Obstruction along the measuring section
 Right image: Measuring without obstruction after change of angle

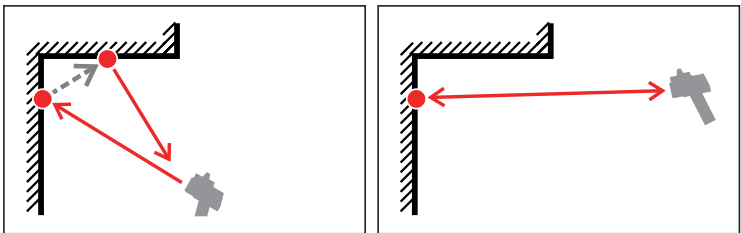

Fig. 15: Error source during measuring (3)
 Left image: Two reflection points in a corner
 Right image: One reflection point after change of position and angle

5 Settings

The following settings can be configured for the detector:

- **Alarm 1** (alarm threshold)
- **Alarm 2** (alarm threshold)
- **Offset** (moving the zero point)
- **Audio** (audible signal for alarm threshold)
- **Language**

5.1 Alarm 1 and Alarm 2

The alarm thresholds can be configured under the menu items **Alarm 1** or **Alarm 2**. **Alarm 1** and **Alarm 2** apply to different modes.

Alarm threshold	Alarm 1	Alarm 2
Applicable to mode	<ul style="list-style-type: none">• Distance• Auto	Sensitivity
Value range	0 – 1000 ppm•m	
Increment	10 ppm•m	

The alarm threshold is set for a specific methane concentration. If a measurement value exceeds the alarm threshold, the detector will trigger an alarm.

The user decides which measurement value the alarm thresholds are set for. The following is common:

- to detect a low methane concentration > set a low alarm threshold
- to detect a high methane concentration > set a high alarm threshold

5.2 Offset

The measurement laser's zero point can be changed to offset an existing basic concentration of methane under menu item **Offset**.

Note:

Configure the offset for a higher value than zero only if there is a known basic concentration of methane in the measurement environment.

Changing the zero point	Offset
Value range	0 – 1000 ppm•m
Increment	10 ppm•m

5.3 Audio

You can set whether an audible signal should sound when the alarm threshold is exceeded under the menu item **Audio**.

- **On**

If a measurement value exceeds the alarm threshold, an audible signal will sound.

- **Off**

If a measurement value exceeds the alarm threshold, no audible signal will sound.

5.4 Language

The language of the user interface can be set under the **Language** menu item.

6 Maintenance

6.1 Detector

6.1.1 Adjusting the detector

The detector must be re-adjusted at least every 3 months. An adjustment takes about 3 minutes.



WARNING! Health hazard from laser radiation in the event of incorrect adjustment

Adjustments not performed in accordance with the instructions can cause hazardous laser radiation.

- Only ever adjust the detector using the adjustment unit integrated in the case.
 - Do not use the adjustment unit if it is damaged.
 - When performing an adjustment, follow the steps below.
-

Note:

The adjustment process can be cancelled at any time using **ESC**.

The detector is in measuring mode. The lasers can be switched off.

1. Remove the protective cap from the lens.
2. Open the main menu.
3. Select **Adjustment**. The start view of the **Adjustment** process will appear (fig. 16, left image).
4. Select **OK** to adjust the detector. A countdown of 10 seconds will begin.
5. During the countdown:
 - place the detector in the case.

The adjustment will automatically start after the countdown. Leave the detector in the case during the adjustment process.

6. Wait until an audible signal indicates the end of the adjustment.

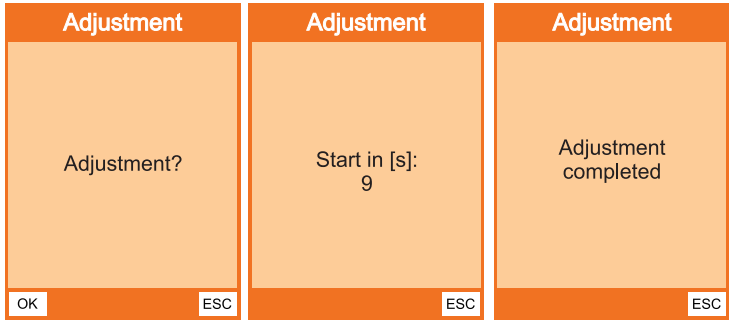

Fig. 16: Adjustment

Left image: Start view

Middle image: Countdown

Right image: Message **Adjustment completed**

6.1.2 Configuring the sight

The following can be configured for the sight:

- size of the red dot
- distance between detector and reflective surface

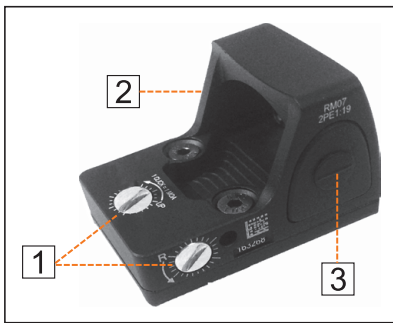

Fig. 17: Sight – adjustment options

1 Adjustment screws, 2 Plus key, 3 Minus key

Size of the red dot

The size of the red dot can be changed.

- Press the plus key to increase the size of the red dot.
- Press the minus key to decrease the size of the red dot.

Note:

Using the minus key, the red dot can be decreased in size so much that it is no longer detectable.

Distance

The sight is always set for a specific distance between the detector and the reflective surface. During the measurement process, this distance must be maintained. If the measurement process is to cover a different distance, the sight must first be re-adjusted.

Note:

The user must remember the distance for which the sight has been set. The set distance is not displayed by the detector.

There must be a suitable reflective surface (e.g. wall). The required distance between the detector and the reflective surface has been measured. The detector is switched off. The lasers are switched on.

1. Position yourself at the required distance to the reflective surface.
2. Remove the protective caps from the lens and the sight.
3. Aim at the reflective surface.
4. Set the sight using the adjustment screws (fig. 18).
 - Look through the sight.
 - Use the tool supplied to make any adjustments.
 - Overlap the red dot with the target laser (fig. 12).

When the red dot and the target laser coincide, the sight has been set for the required distance.

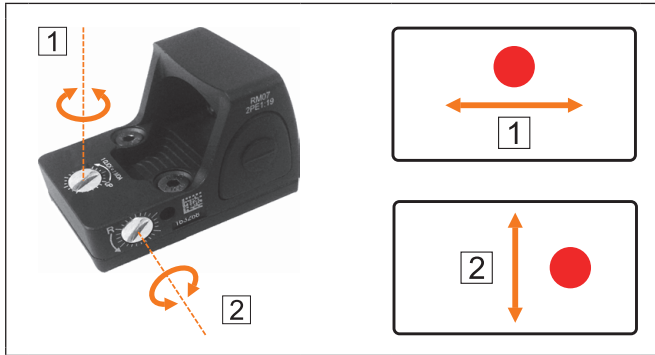

Fig. 18: Sight – setting the distance using the adjustment screws

- 1 Moving the red dot to the right or left
- 2 Moving the red dot up or down

6.1.3 Caring for, storing and transporting the detector

Care

All that is necessary to care for the detector is to wipe it down with a damp cloth when required.

Display, sight and lens

The display, sight glass and lens are sensitive to mechanical and chemical stress.

- Only ever clean the surfaces with a clean, soft cloth (e.g. cloth for cleaning spectacles) or disposable cleaning wipes for optical surfaces.
- Never use cleaning agents containing aggressive constituents (e.g. acidic or abrasive constituents).

Storage and transport

The protective caps and the case protect the detector against dust, moisture and mechanical stress.

When not in use:

- cover the lens and sight of the detector with the protective caps supplied.
- Always store and transport the detector in its case.

6.1.4 Servicing

Note:

Servicing must be performed by specialists.

The device must be serviced once a year.

- Send the device to SEWERIN Service for servicing.
- If you have a service contract, the device can be serviced by the mobile service team.

An inspection sticker on the device confirms the last service and shows the next due date.

6.2 Rechargeable battery

6.2.1 Charging the battery



DANGER! Risk of explosion from sparks

High charging currents occur when batteries are being charged.

- Only ever charge the battery away from explosive environments.
-

The battery must be charged with the supplied charger. The LED on the charger shows the charge status of the battery.

LED	Charge status
red	battery is being charged
green	battery is fully charged (charging process complete)

When charging the battery, the handle can stay on the detector. The spare battery can be charged separately.

The detector is switched off.

1. Lift the protective cap covering the charging socket. Carefully move the protective cap aside.

2. Connect the rechargeable battery to a suitable power source using the charger.

After the charging process:

- Protect the charging socket with the protective cap again.

6.2.2 Replacing the rechargeable battery

The spare battery is integrated in a second handle.

1. Remove the handle attached to the detector.
2. Attach the handle with the spare battery to the detector.

6.2.3 Maintaining and storing the rechargeable battery

If a rechargeable battery is to be stored for long periods, it must be prepared for storage and maintained during storage. This applies to the battery in the handle of the device as well as to the spare battery.

Note:

Observe the permissible storage conditions (section 8.1).

Preparing for storage

- Before storage, charge or discharge the battery to 30 – 50% of its capacity.

Rechargeable battery maintenance during storage

Rechargeable batteries that have completely self-discharged can no longer be charged.

- Charge the battery every 6 months to prevent it from completely self-discharging. Charge the battery only up to approx. 30 – 50% of its capacity.

6.2.4 Handling faulty lithium-ion rechargeable batteries

Rechargeable lithium-ion batteries are always classed as dangerous goods for transport purposes.

Transport of faulty lithium-ion batteries is only permitted under certain conditions (e.g. must not be transported as air freight). Where transport is permitted (e.g. by road or rail), it is subject to strict regulations. Transport by road or rail must take place in compliance with the current applicable version of the ADR1 regulations.

Identifying faulty rechargeable batteries

A rechargeable lithium-ion battery is considered to be faulty if one of the following criteria applies:²

- housing damaged or badly deformed
- liquid leaking from battery
- smell of gas from battery
- rise in temperature when switched off (more than warm to the touch)
- plastic parts melted or deformed
- connection leads melted

¹ French abbreviation for: Accord européen relatif au transport international des marchandises Dangereuses par Route, *Engl.: European Agreement concerning the International Carriage of Dangerous Goods by Road

² According to: EPTA – European Power Tool Association

7 Faults and problems

7.1 Error messages

Error message	Possible cause	Corrective action
Temperature	Detector temperature outside operating temperature	– Switch off detector and wait until it returns to the operating temperature. You may have to take the detector to a cooler or hotter environment.
	Laser control faulty	– Contact SEWERIN Service
Light weak	Surface does not reflect sufficiently.	– Aim the detector at the target at another angle. – Aim at a more suitable reflective surface.
	Target outside maximum range	– Reduce distance to target.
Light strong	Surface reflects too much.	– Aim the detector at the target at another angle. – Aim at a more suitable reflective surface.
Adjustment failed	Obstruction between lens and adjustment unit (e.g. protective cap)	– Remove the obstacle.
	Adjustment unit damaged (e.g. crack in the glass)	– Replace the adjustment unit.

7.2 Fixing problems yourself

Problem	Possible cause	Corrective action
The detector will not switch on	Discharge the rechargeable battery	– Charge or replace the rechargeable battery.
No red dot detectable in sight	Laser not switched on	– Switch on the laser.
	Red dot excessively reduced	– Increase the red dot.
Known methane concentration cannot be measured	Detector out of adjustment	– Adjust the detector.

Problem	Possible cause	Corrective action
Signal (light intensity) weak for extended duration	Measurement laser exit opening dirty from particles (e.g. dust)	– Clean the exit opening with a dusting brush, a cloth for cleaning spectacles or a disposable cleaning wipe for optical surfaces.
Alarm threshold permanently exceeded	Alarm threshold set too low	– Set the alarm threshold higher.
No audible signal with high methane concentration	Alarm threshold set too high	– Set the alarm threshold lower.
	Audible signal deactivated	– Activate audible signal.
Significant, unexpected fluctuations between low and high measurement values	Detector moved too fast	– Repeat the measurement while moving the detector at a slower, smooth speed.
	Detector not moved smoothly	
	Long range (the greater the distance, the more difficult aiming can be)	– Perform the detection process from a shorter distance.
	Reflective surface has irregular surface	– Change the angle. – Choose a different reflective surface.
	Strong winds	– Repeat the measurement with better/more stable ambient conditions.
Higher measurement values than usual for short-range measurements OR Lower measurement values than usual for long-range measurements	Detector out of adjustment	– Adjust the detector.

Contact SEWERIN Service if you cannot fix a fault yourself or if problems occur repeatedly.

8 Appendix

8.1 Technical data

Device data

Dimensions (W × D × H)	58 × 130 × 202 mm
Weight	623 g

Features

Display	LCD 1.8" 240 × 320 pixels
Interface	<ul style="list-style-type: none">• charging socket• Bluetooth
Control	3 keys
Sensor	laser: <ul style="list-style-type: none">• measurement laser
Other features	<ul style="list-style-type: none">• audible alarm, can be deactivated• target laser• red dot sight

Operating conditions

Operating temperature	-20 – 50 °C
Humidity	30 – 90% r.h., non-condensing
Atmospheric pressure	800 – 1100 hPa
Protection rating	IP54
Non-permitted operating environments	in potentially explosive areas

Storage conditions

Storage temperature	-20 – 50 °C
Humidity	30 – 90% r.h., non-condensing

Power supply

Power supply	lithium-ion battery (rechargeable) [9066-4003]
Net weight of batteries	<ul style="list-style-type: none">• weight per cell: 0.0475 kg• total: $3 \times 0.0475 \text{ kg} = 0.143 \text{ kg}$
Operating time, typical	> 13 h
Battery power	36 Wh
Charging time	approx. 2.5 h
Charging temperature	10 – 45 °C
Charging voltage	12.6 V
Charging current	2 A
Charging socket	USB-C (approved for supplied charger only)
Charger	charger SR-LD

Measurement laser

Laser class	1 (according to IEC 60825-1)
Feature	<ul style="list-style-type: none">• infrared laser• invisible• distance for the safe detection of 100 % vol. CH₄ at 10 l/h: 50 m
Wavelength	1653 nm
Measuring range	0 – 100,000 ppm•m methane
Resolution	5 ppm•m
Detection range	0.5 – 120 m (in ideal ambient conditions)
Response time	0.05 s

Target laser

Laser class	2 (according to IEC 60825-1)
Feature	colour: green
Wavelength	530 nm
Output power	≤ 1 mW

8.2 Delivery contents

- Carrying case
 - for transport and storage
 - with adjustment unit
- Hand strap
 - for the safe handling of the detector
- Charger
- Spare rechargeable battery
 - integrated in a second handle
- Tools
 - for replacing the rechargeable battery and for configuring the sight
- Protective caps for lens and sight

8.3 Factory settings

Menu item	Value
Alarm 1	100
Alarm 2	50
Offset	0
Audio	On
Language	English

8.4 Sticker on the detector and rechargeable battery

The detector and the rechargeable battery are marked in accordance with statutory regulations.

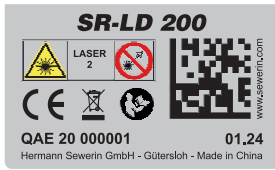

Fig. 19: Sticker on the bottom of the housing



Fig. 20: Sticker on the handle (rechargeable battery)

Symbols on the stickers



Follow the operating instructions!



Laser radiation



Do not look into the laser beam!



Do not dispose of in domestic waste!



CE mark





Recycle the lithium-ion rechargeable battery!

8.5 Symbols on the display

Symbols that are shown on the display without a descriptive text are explained below.

 Signal

 Audio (audible signal for alarm threshold activated)

 Audio (audible signal for alarm threshold deactivated)

 Charge status

 Bluetooth

8.6 Conversion of concentration data

Gas concentrations are specified in the unit ppm or % vol.

Conversion: 1 % vol. = 10,000 ppm

 0.1 % vol. = 1,000 ppm

8.7 Terminology and abbreviations

Angle (of incidence)

Angle at which the laser beam meets the reflective surface

ppm·m (parts per million meter)

Unit of the integral gas concentration The associated value is calculated using the product of the line traced by the laser beam in a gas cloud multiplied by the methane concentration.

Reflective surface

Surface reflecting a laser (e.g. wall, ground, pipeline)

TDLAS

Engl. abbreviation for: Tunable Diode Laser Absorption Spectroscopy

A method of determining the density or concentration of gases using a laser

8.8 Declaration of Conformity

Hermann Sewerin GmbH hereby declares that the **SR-LD 200** detector fulfils the requirements of the following guidelines:

- **2011/65/EU**
- **2014/30/EU**
- **2014/53/EU**

The complete Declaration of Conformity can be found online.

8.9 Advice on disposal

The European Waste Catalogue (EWC) governs the disposal of devices and accessories in accordance with EU Directive 2014/955/EU.

Waste	EWC code
Device	16 02 13
Lithium-ion rechargeable battery	16 06 05

Alternatively, you can return devices to SEWERIN.

9 Index

A

- Adjustment 24
 - unit 6
- Adjustment failed (error message) 31
- Aiming 17
 - using the sight 17
 - using the target laser 17
- Alarm 1/2 22
- Alarm threshold 22
 - exceeded 7
- Ambient conditions 20
- Audible signal 7, 9
 - activating 15
 - deactivating 15
- Audio 23
- Auto (mode) 9

C

- Care 27
- Conversion of concentration data 37

D

- Delivery contents 35
- Detecting 19
 - errors 20
 - requirements 19
- Detector
 - adjusting 24
 - handling 19
 - switching off 13
 - switching on 13
- Distance (mode) 9

E

- Error messages 31

F

- Factory settings 35
 - resetting to factory settings 16
- Features 4
- Fixing problems 31

G

- Gas concentration
 - conversion 37
 - integral 10
 - measuring 20
 - unit 10

H

- Handling the detector 19

I

- Influences on the measurement result 19

K

- Key functions 12

L

- Language 23
- Lasers 4
 - exit openings 4
 - switching off 14
 - switching on 14
- LED 28
- Light strong (error message) 31
- Light weak (error message) 31
- Lithium-ion rechargeable battery 30
 - charge status (LED display) 28
 - safety information 3

M

- Main menu 8
 - opening 15
- Maintenance 24
- Maximum value 7
- Measured variable 10
- Measurement
 - laser 4
 - result 19
- Measurement value
 - current 7
 - maximum value 7

- Measuring mode 7
 - switching to the menu 15
- Menu 8
 - adjustment 24
 - reset 16
 - settings 22
 - structure 8
 - switching to measuring mode 15
- Mode 9
 - switching 14

O

- Offset 23

P

- Power supply 6

R

- Rechargeable battery
 - charging 28
 - identifying a fault 30
 - maintaining 29
 - replacing 29
 - storing 29
- Reflective surface 19
- Requirements for detection 19
- Reset 16

S

- Sensitivity (mode) 9
- Servicing 28
- Settings 22
 - alarm 1/2 22
 - audio 23
 - changing 15
 - language 23
 - offset 23
- Setting the distance 26
- Sight 5
 - aiming 17
 - configuring 25
 - distance 26
 - size of the red dot 25
- Signal quality 19
- Sticker 36
- Storage 27

- Switching off
 - detector 13
 - lasers 13
- Switching on
 - detector 13
 - lasers 13
- Symbols
 - display 37
 - stickers 36

T

- Target laser 4, 17
- Temperature (error message) 31
- Transport 27



Hermann Sewerin GmbH

Robert-Bosch-Straße 3
33334 Gütersloh, Germany
Tel.: +49 5241 934-0
Fax: +49 5241 934-444
www.sewerin.com
info@sewerin.com

SEWERIN IBERIA S.L.

Centro de Negocios Eisenhower
Avenida Sur del Aeropuerto
de Barajas 28, Planta 2
28042 Madrid, España
Tel.: +34 91 74807-57
Fax: +34 91 74807-58
www.sewerin.com
info@sewerin.es

Sewerin Sp. z o.o.

ul. Twórcza 79L/1
03-289 Warszawa, Polska
Tel.: +48 22 675 09 69
Tel. kom.: +48 501 879 444
www.sewerin.com
info@sewerin.pl

SEWERIN SARL

17, rue Ampère – BP 211
67727 Hoerdts Cedex, France
Tél. : +33 3 88 68 15 15
Fax : +33 3 88 68 11 77
www.sewerin.fr
sewerin@sewerin.fr

Sewerin Portugal, Lda

Rua Sr. Dos Milagres, 16, 2º Esq
3800-261 Aveiro, Portugal
Tlf.: +351 234 133 740
Fax.: +351 234 024 446
www.sewerin.com
info@sewerin.pt

Sewerin Ltd.

Hertfordshire
UK
Phone: +44 1462-634363
www.sewerin.co.uk
info@sewerin.co.uk